

ASTOPAD[®]

PATIENT WARMING SYSTEM

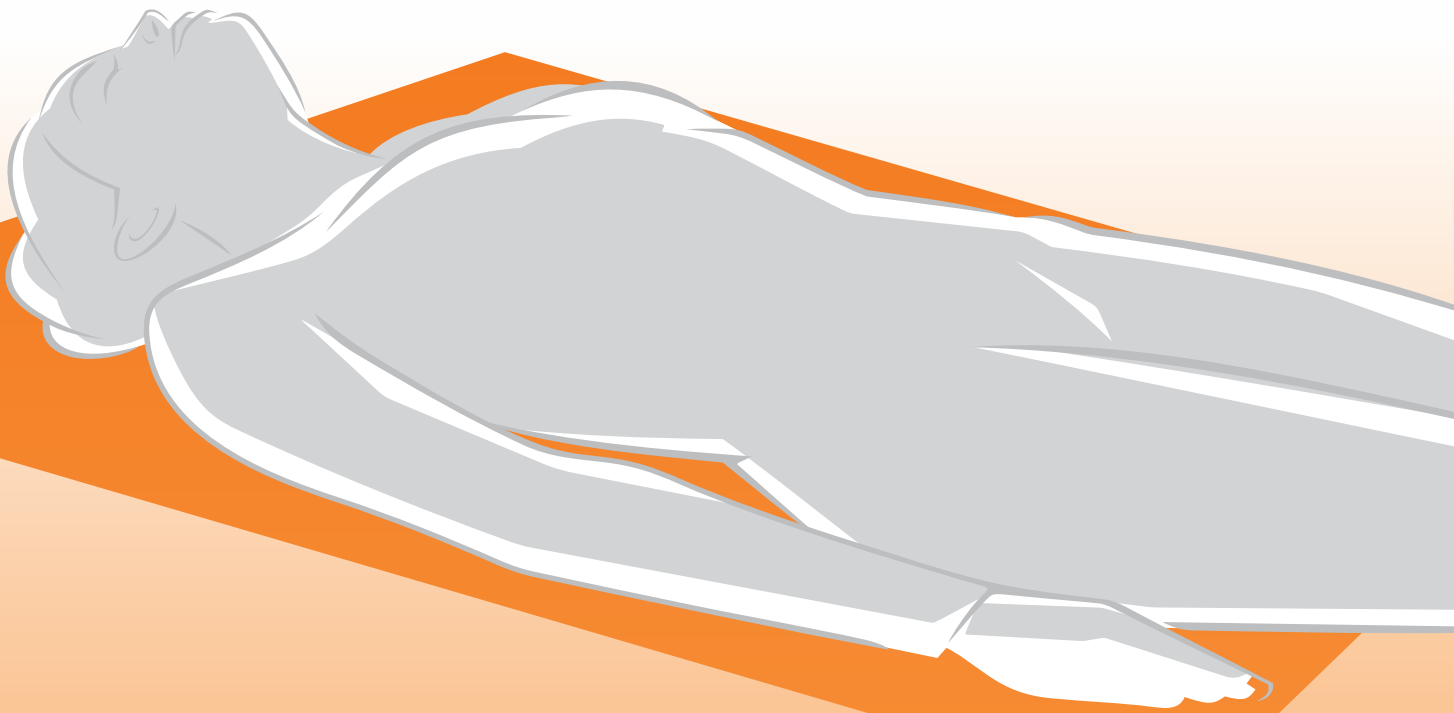

universal . modular . conductive

STIHLER ELECTRONIC

High quality products for the medical field

ASTOPAD® PATIENT WARMING SYSTEM

universal . modular . conductive

ASTOPAD: The flexible, conductive and reusable patient warming system is very economical, simple to operate and of great clinical benefit. As the first module for the reduction of perioperative hypothermia, in routine use, **ASTOPAD** provides effective and economical prevention for all surgical patients. It improves safety against negative side effects of operations and contributes to the general well-being of the patient. It also provides prevention against decubitus when combined with a visco-elastic operating table pad or **ASTOGEL** gel pad.



Two **ASTOPAD** applied parts can be independently controlled using the **ASTOPAD DUO310** control unit. The patient can be simultaneously warmed from above and below. The temperature setting in the range from 32 - 39°C can be individually set in precise 0.5°C steps for each applied part. All high and low temperature alarms are continuously monitored by the control unit. The illuminated display and simple operation ensure safe use of the **ASTOPAD** patient warming system.

ASTOPAD DUO310 control units are prepared for battery operation and can optionally be operated with an integratable, rechargeable battery.

The heat is generated by a 24 Volt protective low voltage for all **ASTOPAD** applied parts, using a net of carbon fibre which is permeable to X-rays. 4 or 8 temperature sensors are distributed close to the patient in the applied part. These ensure precise temperature control and monitoring of all of the alarm functions of the **ASTOPAD** patient warming system.

All **ASTOPAD** applied parts are wipeable and can be disinfected. They are supplied with a reusable cover which can be washed at 95°C and disinfected, optionally with a special fixation cover.

ASTOPAD COV warming blankets are exceedingly soft and supple. They can be used before, during and after surgery, as well as on the ward.

ASTOPAD SOF/ROE, the heated, pressure relieving operating table pad provides a unique combination of hypothermia and decubitus prophylaxis.

The key component of the **ASTOPAD SOF** is a visco-elastic foam, combined with a dynamic foam base for the best possible decubitus prophylaxis on the operating table.

ASTOPAD ROE, the special X-ray permeable applied part is based on an optionally 40 mm or 80 mm thick visco-elastic foam with a maximum sensor-free zone.

Hospital situations and solutions

The first module for perioperative hypothermia prophylaxis should always be the heated and soft positioning of the patient. The wide range of **ASTOPAD** applied parts makes it possible to achieve optimal hypothermia and decubitus prophylaxis with every existing or new operating table.

Examples:







1 Existing operating table pads made from visco-elastic foam are best combined with **ASTOPAD COV** applied parts. In this way, an existing soft operating table pad (pressure sore prophylaxis) becomes a soft and heated operating table pad due to the flexible **ASTOPAD COV** warming blanket. **ASTOPAD COV** warming blankets do not have any negative effects on the pressure relieving properties of the visco-elastic foam. This achieves optimum prophylaxis against hypothermia and decubitus.

2 Existing operating table tops made from "hard" integral foam are best combined with **SOF** applied parts (with fixation cover).

This achieves a heated and soft position for the patient without extensive conversion of the operating table, which at the same time enables prophylaxis against hypothermia and decubitus. Alternatively a combination of **ASTOGEL** gel pads with **ASTOPAD COV** applied parts can be used.

3 Ideally, new operating tables or operating table conversions are directly equipped with **ASTOPAD SOF** applied parts for the backrest pad or the entire surface of the operating table.

The **ASTOPAD SOF** applied parts are produced individually in the necessary sizes for the operating table and provide optimum prophylaxis against hypothermia and decubitus.

Applied parts	Designation	Use
	ASTOPAD COV070 680 x 480 mm	Warming blanket as a top and bottom blanket for children and infants with a height of less than 90 cm.
	ASTOPAD COV105 1050 x 500 mm	Special warming blanket for surgery in the lithotomy position (primarily urology and gynaecology).
	ASTOPAD COV150 1500 x 500 mm	Heated standard model for universal use as a top and bottom blanket.
	ASTOPAD COV155 1500 x 500 mm	Warming blanket to cover the upper body with cut-outs for the neck and thorax area.
	ASTOPAD COV180 1800 x 800 mm	Heated full body blanket, as a top and bottom blanket for the operating theatre, recovery room and on the ward.
	ASTOPAD COV235 2050 x 1350 mm	Heated top blanket for use in the recovery room and on the ward.
	ASTOPAD SOF7 Length 600 - 800 mm (with sacral 660 - 900 mm), width 450 - 600 mm, height 40 - 100 mm	Heated, pressure relieving backrest for operating tables, antistatic. The dimensions are adapted individually, so that it is suitable for all operating tables. All backrests are optionally available with a sacral cut-out.
	ASTOPAD SOF4 Length 810 - 1300 mm (with sacral 910 - 1300 mm), width 480 - 600 mm, height 40 - 100 mm	
	ASTOPAD SOF5 Length 1310 - 1700 mm, width 480 - 600 mm, height 40 - 100 mm	
	ASTOPAD SOF2 Length 1710 - 2300 mm, width 480 - 600 mm, height 40 - 100 mm	Heated, pressure relieving operating table mattress, antistatic. The dimensions are individually adapted to the operating table.
	ASTOPAD ROE4 Height 40 mm, length 2400 - 2800 mm	Heated, pressure relieving operating table mattress for hybrid operating theatres, antistatic. The dimensions are individually adapted to the operating table.
	ASTOPAD ROE8 Height 80 mm, length 2400 - 2800 mm	
Accessories	Designation	Use
	Reusable cover for all COV applied parts	Used to protect the heated blanket. The reusable cover can be disinfected and washed at 95°C.
	Fixation cover for COV070, COV105 and COV150 applied parts	Used to protect the heated blanket. The reusable cover can be disinfected and washed at 95°C. If the warming blanket is used as a lower blanket on the operating table, it can be securely fixed to the standard rail with the fixation cover.
	Fixation cover for all SOF applied parts	Used to protect the operating table pad. The reusable cover can be disinfected and washed at 95°C. This is recommended if the SOF is attached to an existing operating table pad.
	Reusable cover for all SOF applied parts	Used to protect the operating table pad. The reusable cover can be disinfected and washed at 95°C. Recommended if the SOF is attached to the operating table with Velcro tape.
	Mattress cover for ROE applied parts	Used to protect the ROE mattress. The reusable cover can be disinfected and washed at 95°C.

Application examples

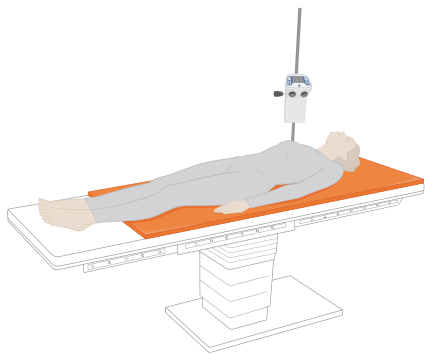

ASTOPAD COV150

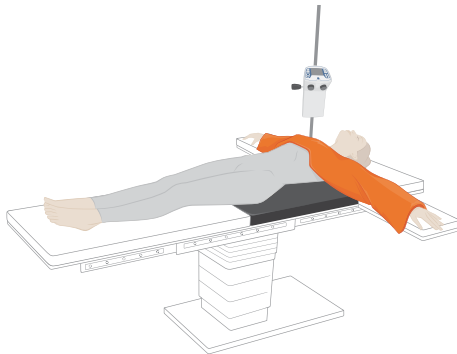

ASTOPAD SOF4
ASTOPAD COV155

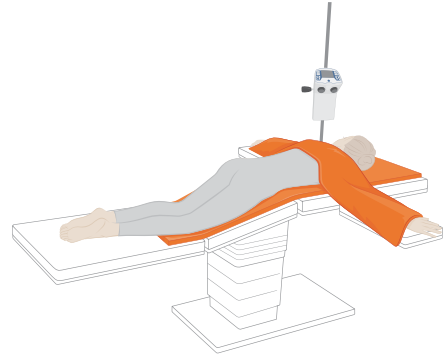

ASTOPAD COV150
ASTOPAD COV155

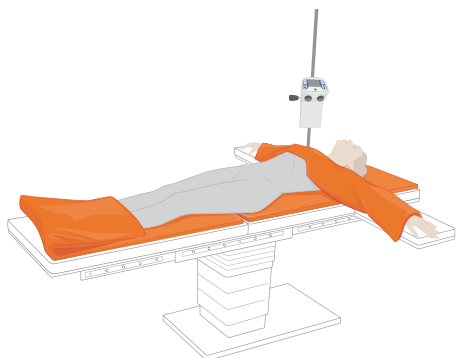

ASTOPAD COV105
ASTOPAD COV150
ASTOPAD PAS155

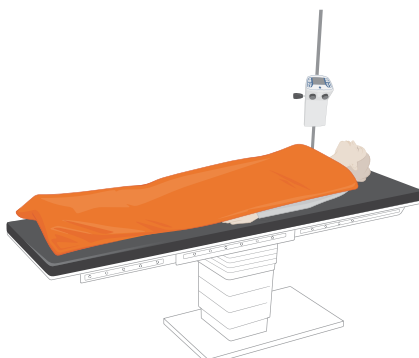

ASTOPAD SOF2
ASTOPAD COV180

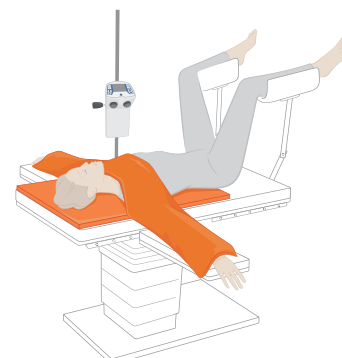

ASTOPAD COV105
ASTOPAD COV155

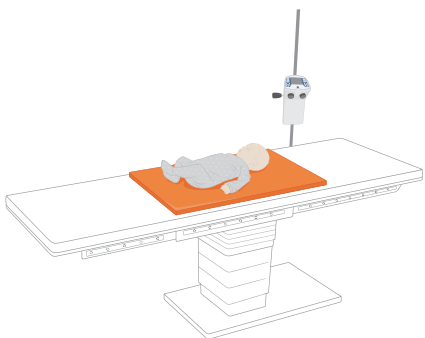

ASTOPAD COV070

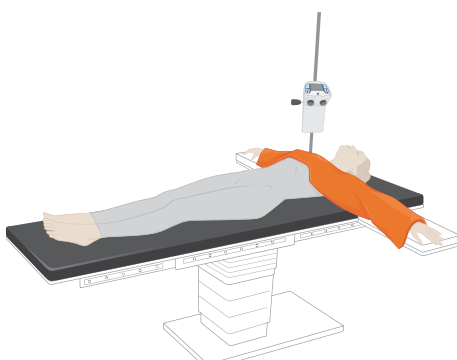

ASTOPAD SOF2
ASTOPAD COV155

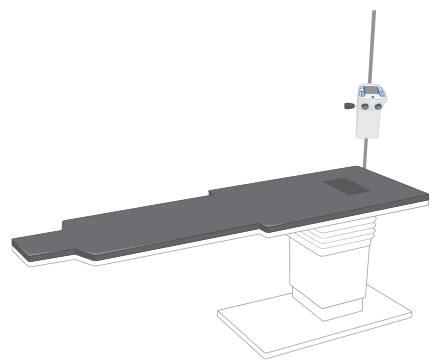

ASTOPAD ROE4 / ROE8

Stihler Electronic GmbH
Julius-Hoelder-Strasse 36
70597 Stuttgart
Germany

Tel.: +49 (0) 711 72067-0
Fax: +49 (0) 711 72067-57

www.stihlerelectronic.de
E-Mail: info@stihlerelectronic.de

CE 0124

© 2017 STIHLER ELECTRONIC GMBH REV. 01
Technical modifications reserved